



AMH series handles

- Ergonomic design
- Available with different proportional and ON/OFF functions
- High resistance thermoplastic material
- Plate with customizable symbols

General features

Body, shell and plate material	Nylon® 6, 30% SV
IP weather protection (assembled)	depending on configuration
Ambient temperature	from -20°C to 60°C / from -4°F to 140°F
UV resistance	according to IEC68-2-5, S test C procedure

Electric device features

ON/OFF push button with detent

Version	with detent	
Contact type	NA	
Current rating	200 mA @ 12 VDC	
Mechanical life (nr. of operations)	10 ⁶	
Electric life (nr. of operations)	5x10 ⁵	
Weather protection	IP67 with handle mounting	

LED

Supply voltage (max.)	12V (10 mA)	
-----------------------	-------------	---

ON/OFF push button

Version	ritorno a molla	
Contact type	NA	
Current rating	2 A resistive load @ 12 VDC	
Mechanical life (nr. of operations)	10 ⁶	
Electric life (nr. of operations)	200x10 ³	
Weather protection	IP67 with handle mounting	

Proportional roller

Supply	9-32 VDC	
Max. current consumption	< 24 mA	
Max. output current	1 mA	
Output signal (range)	0.5 - 4.5 V	
Output signal (central position)	2.5V	
Signal tolerance (central position and stroke end)	±100 mV	
Minimum load	10 Ω	
Actuator deflection angle	± 35° (±1°)	
Mechanical life (nr. of operations)	10 ⁶	
Operating force	2 N	
Mechanical vibration	IEC 68-2	
Mechanical shock	EN 60068-2-29 (pulse 400m/s ² x 6 ms, 100 times)	
Weather protection	IP67-IP69K	
EMC compatibility	ISO 13766 ISO 14982	

Cables

Conductor material	copper with tinned ends
Nr. of conductors	up to 12
Conductor section	from AWG16 to AWG20
Insulating material	PVC
Protective covering material	fireproof polyurethane

Dimensions

Operator view

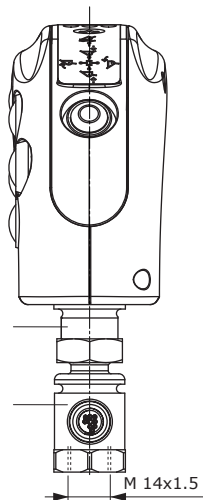

Side view

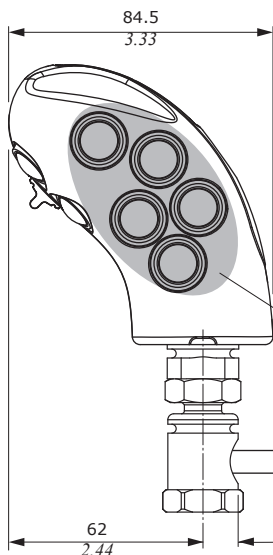

Front view

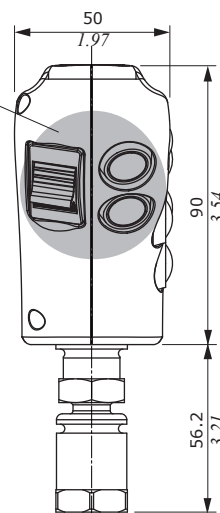

Front zone
It can be configured up to 4 push-buttons or up to 2 push-buttons and 1 roller

Side zone
It can be configured up to 5 push-buttons or up to 2 push-buttons and 1 roller

tinned ends

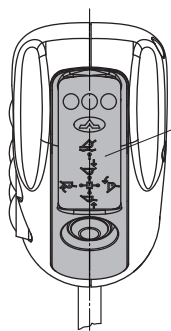

Holder plate

It can be configured up to 1 push-button and 3 LEDs with or without normative

NOTES

Configuration with 2 roller is not available.
The handle can be configured with up to 4 push-buttons with protection diode.

Proportional roller output detail

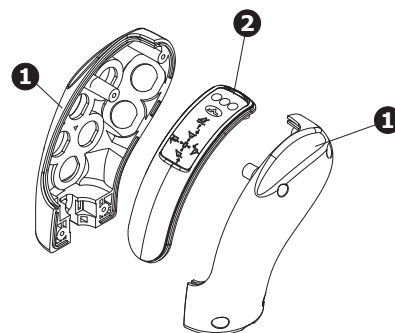
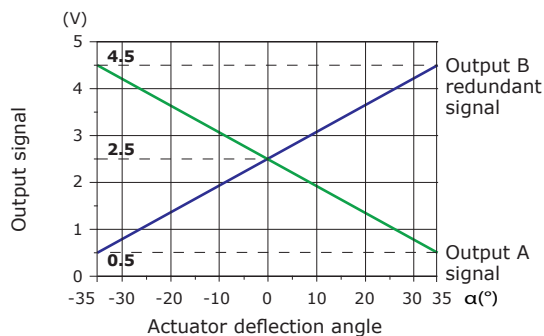

- 1) Half-shell
- 2) Holder plate
- 3) Universal joint
- 4) Additional joint
- 5) Cable

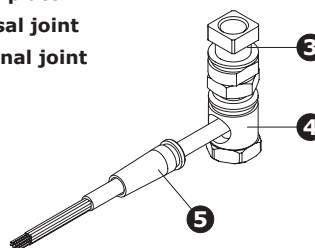

Configurations

Code	2IM3000000
Description	AMH0000A9-(E2)
Plate	Without push-buttons and LED
Front zone	Without push-buttons
Side zone	Without push-buttons
Joint	Standard for SVM400-430 joystick

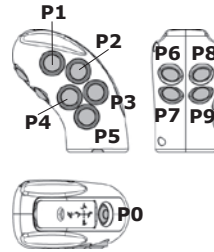
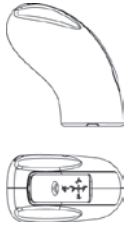

Code	2IM3000001
Description	AMHT1000A9-0R3035-1R2035-2R2035-3R2035-4R2024-5R2035-6R2D035-7R2D035-8R2D035-9R2D035-(E3)
Plate	1 push-button with detent (P0)
Front zone	4 push-buttons with spring return (P6-P7-P8-P9)
Side zone	5 push-buttons with spring return (P1-P2-P3-P4-P5)
Joint	Standard for SVM400-430 joystick

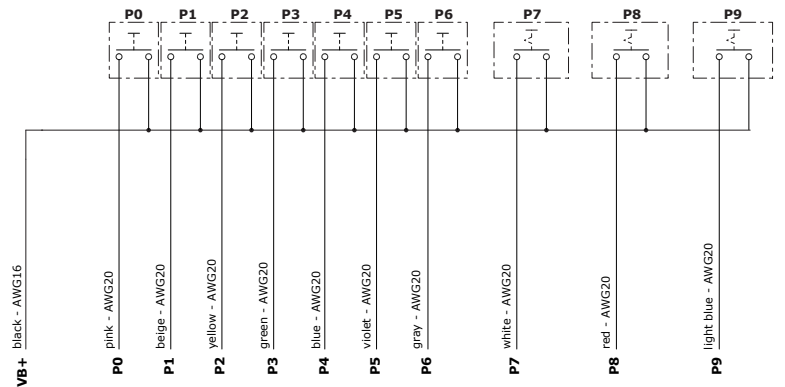

Code	2IM3000002
Description	AMHT0403A9-0RF035-6R2035-7R2035-8R2035-ALV035-BLV035-CLR035-(12VDC)-(E3)
Plate	3 LED (L1-L2-L3) 12 VDC, 1 push-button with detent (P0)
Front zone	3 push-buttons with spring return (P6-P7-P8)
Side zone	Without push-buttons
Joint	Standard for SVM400-430 joystick

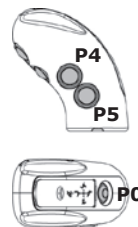
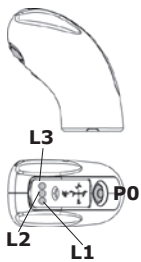

Code	2IM3000003
Description	AMHT0700A9-0RF035-4R2035-5R2035-6R2035-7R2035-8R2035-9R2035-(E2)
Plate	1 push-button with detent (P0)
Front zone	4 push-buttons with spring return (P6-P7-P8-P9)
Side zone	2 push-buttons with spring return (P4-P5)
Joint	Standard for SVM400-430 joystick

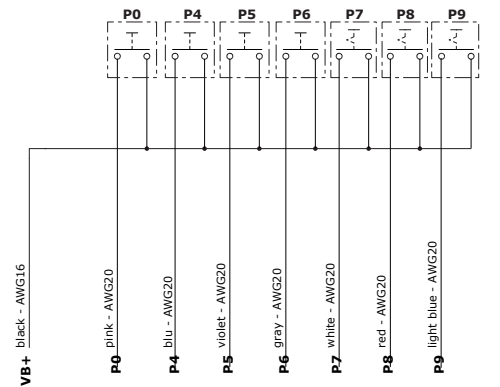
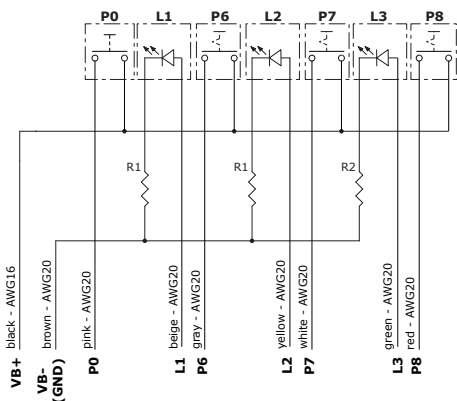



NOTE - For different joint see page 4. For different handle configurations, contact our Sales Dept.

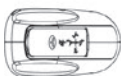

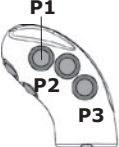
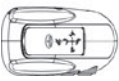
Configurations

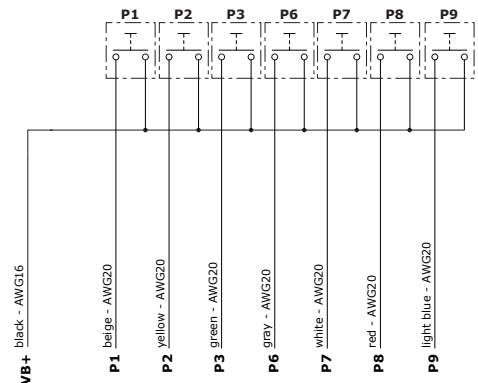
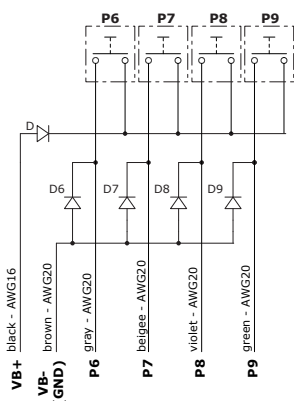
	Code	2IM300004
	Description	AMH0400A9-6R2035-7R2035-8R2035-9R2035-(E2)
	Plate	Without push-buttons and LED
	Front zone	4 push-buttons with spring return (P6-P7-P8-P9) with protect diode
	Side zone	Without push-buttons
	Joint	Standard for SVM400-430 joystick

	Code	2IM300005
	Description	AMH0700A9-1R2035-2R2035-3R2035-6R2035-7R2035-8R2035-9R2035-(E3)
	Plate	Without push-buttons and LED
	Front zone	4 push-buttons with spring return (P6-P7-P8-P9)
	Side zone	3 push-buttons with spring return (P1-P2-P3)
	Joint	Standard for SVM400-430 joystick

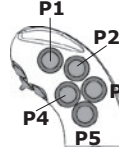

	Code	2IM3100000
	Description	AMHT0410A9-3R2D035-5R2D035-6R2D035-7R2D035-WN140035-(E1)
	Plate	Without push-buttons
	Front zone	2 push-buttons with spring return (P6-P7) with protect diode
	Side zone	2 push-buttons with spring return (P3-P5) with protect diode, 1 proportional roller (W)
	Joint	Standard for SVM400-430 joystick

	Code	2IM3100001
	Description	AMHT0810A9-0RF035-1R2035-2R2035-3R2035-4R2035-5R2035-8R2035-9R2035-ZN140035-(E1)
	Plate	1 push-button with detent (P0)
	Front zone	2 push-buttons with spring return (P8-P9), 1 proportional roller (Z)
	Side zone	5 push-buttons with spring return (P1-P2-P3-P4-P5)
	Joint	Standard for SVM400-430 joystick

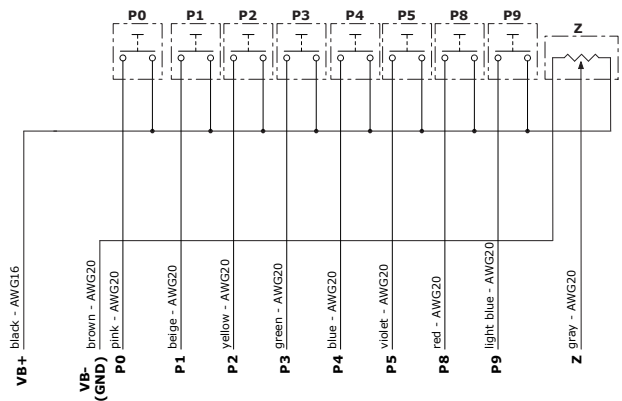
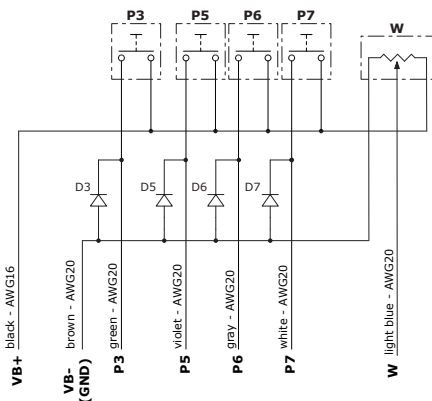

NOTE - For different joint see page 4. For different handle configurations, contact our Sales Dept.