



## MP..X type pressure relief valves - 2 way

- Solenoid proportional type, pilot operated
- Increasing pressure with increasing current (NO)
- Spool type
- From SAE10 to SAE12 cavities

Technical specifications and diagrams are measured with mineral oil of 46 cSt viscosity at 40°C (104°F) temperature.

		MP10X	MP12X
Max. flow		60 l/min (16 US gpm)	120 l/min (31.7 US gpm)
Max. pressure		350 bar (5100 psi)	
Oil leakage	at 80% of max. pressure setting	<150 cm <sup>3</sup> /min (9.15 in <sup>3</sup> /min)	<180 cm <sup>3</sup> /min (10.1 in <sup>3</sup> /min)
Fluid		mineral based oil	
Viscosity		10-200 cSt	
Max level of contamination		18/16/13 ISO4406	
Fluid temperature	with NBR seals with FPM seals	from -20°C (-4°F) to 80°C (176°F) from -20°C (-4°F) to 100°C (212°F)	
Environmental temp. for working conditions		from -40°C (-40°F) to 100°C (212°F)	
Cavity		SAE 10/2	SAE 12/2
Coil type*		BH or BQP19	
Nominal voltages		12 VDC - 24 VDC	
Power rating		20.4 W (BH) - 15 W (BQP19)	
Max control current		12 V -> 1.70 A - 24 V -> 0.85 A (BH) 12 V -> 1.25 A - 24 V -> 0.63 A (BQP19)	
Dither frequency		180 Hz	180 Hz
Hysteresis		<5%	
Weight		0.76 kg (1.67 lb)	0.88 kg (1.94 lb)

NOTE - For different conditions, please contact Walvoil Sales Dpt. - For coils further features see from page 206

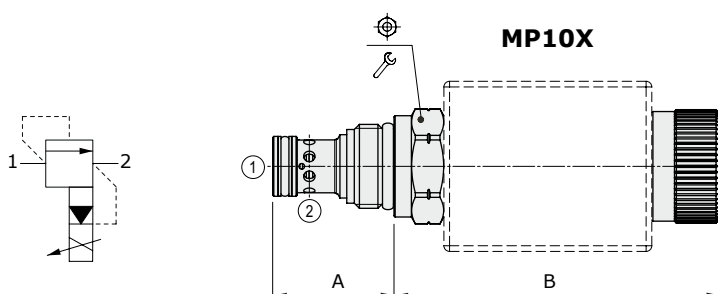

Valve type	A		B		⌀	⌘	Nm	lbft
	mm	in	mm	in				
MP10X/0	32.3	1.27	86	3.39	27	50	37	
MP12X/0	45	1.81	102	4.02	32	80	59	

For dimensions with different type of emergency see page 213

### Ordering codes and description composition

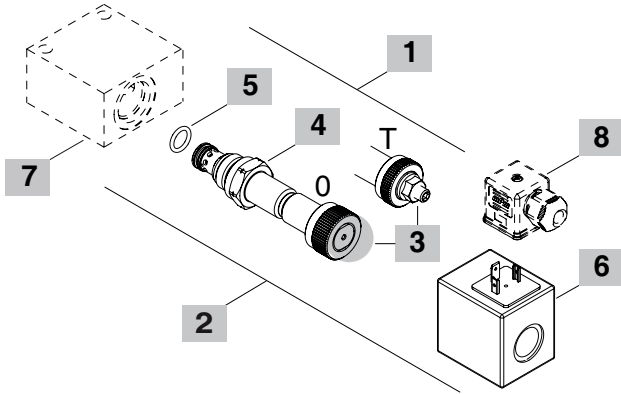
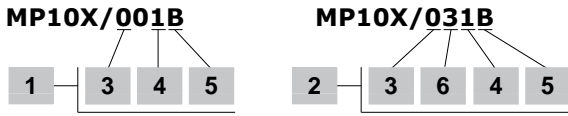

#### 1 Cartridges

TYPE	CODE	DESCRIPTION
<b>SAE cavity 10/2</b>		
MP10X/001B	OMP10002054	Pressure range 1
MP10X/002B	OMP10002055	Pressure range 2
MP10X/003B	OMP10002056	Pressure range 3
MP10X/004B	OMP10002057	Pressure range 4
<b>SAE cavity 12/2</b>		
MP12X/001B	OMP12002031	Pressure range 1
MP12X/002B	OMP12002032	Pressure range 2
MP12X/003B	OMP12002033	Pressure range 3
MP12X/004B	OMP12002034	Pressure range 4

#### 2 Complete cartridges

TYPE	CODE	DESCRIPTION
<b>SAE cavity 10/2</b>		
MP10X/031B	OMP10002044	Pressure range 1, 12VDC
MP10X/032B	OMP10002045	Pressure range 2, 12VDC
MP10X/033B	OMP10002046	Pressure range 3, 12VDC
MP10X/034B	OMP10002047	Pressure range 4, 12VDC
<b>SAE cavity 12/2</b>		
MP12X/031B	OMP12002023	Pressure range 1, 12VDC
MP12X/032B	OMP12002024	Pressure range 2, 12VDC
MP12X/033B	OMP12002025	Pressure range 3, 12VDC
MP12X/034B	OMP12002026	Pressure range 4, 12VDC

#### 3 Emergency

TYPE	DESCRIPTION
0	Without override
T	With screw

#### 4 Pressure range

TYPE	DESCRIPTION
1	Pressure range 10÷120 bar (145÷1740 psi)
2	Pressure range 10÷160 bar (145÷2320 psi)
3	Pressure range 10÷230 bar (145÷3335 psi)
4	Pressure range 10÷350 bar (145÷5100 psi)

Note: for further pressure range contact Sales Dept.

#### 5 Seals

TYPE	DESCRIPTION
B	<b>NBR (Buna)</b> o-ring seals, std configuration
V	<b>FPM (Viton)</b> o-ring seals, contact Sales Dept.

#### 6 Coils

TYPE	CODE	DESCRIPTION
2) BH 12VDC	4SLD001200	12VDC-ISO4400 coil
3) BQP19 12VDC	4SL5000126	12VDC-ISO4400 coil
4) BH 24VDC	4SLD002400	24VDC-ISO4400 coil
5) BQP19 24VDC	4SL5000245	24VDC-ISO4400 coil

For complete coils list see from page 206

#### 7 Valve body

TYPE	CODE	DESCRIPTION
<b>SAE 10/2-G 3/8</b>	3CC1020C11	Aluminium body for cavity 10 valve, G 3/8 std thread
<b>SAE 12/2-G 1/2</b>	3CC1220D11	Aluminium body for cavity 12 valve, G 1/2 std thread

Note: aluminium body can stand up to 210 bar (3050 psi)

For steel bodies or different threading see from page 215

#### 8 Connector

TYPE	CODE	DESCRIPTION
<b>ISO4400</b>	4CN1009995	Connector

For complete connectors list see from page 206

### Rating diagrams

**MP10X pressure setting vs. % max. control current**  
at 5 l/min (1.32 US gpm)

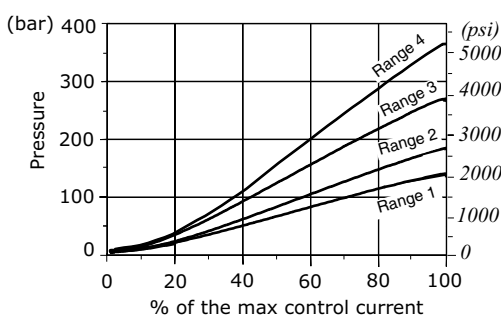

**MP10X pressure vs. flow 1->2**  
for % of control current - Pressure range 1 -

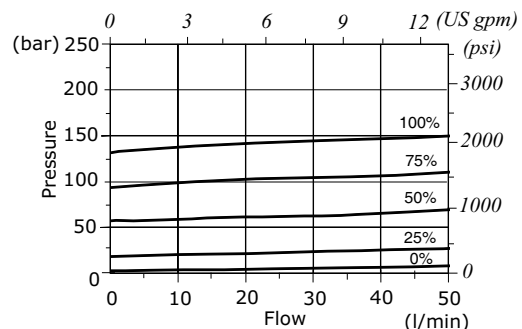

**Rating diagrams**

**MP10X pressure vs. flow 1->2**

for % of control current - Pressure range 2 -

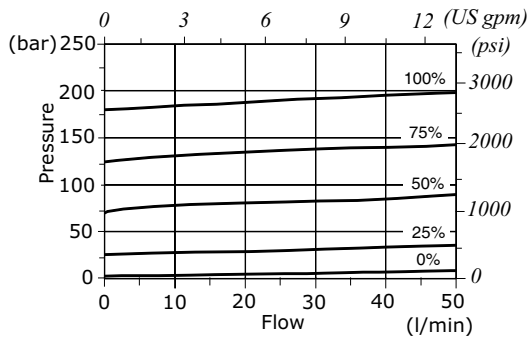

**MP10X pressure vs. flow 1->2**

for % of control current - Pressure range 3 -

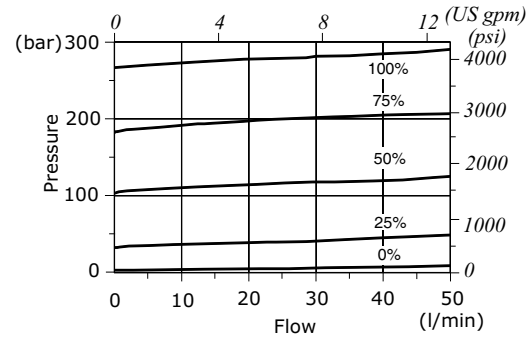

**MP10X pressure vs. flow 1->2**

for % of control current - Pressure range 4 -

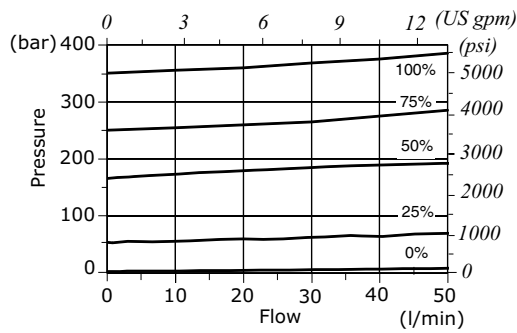

**MP12X pressure setting vs. % max. control current**

at 10 l/min (2.64 US gpm)

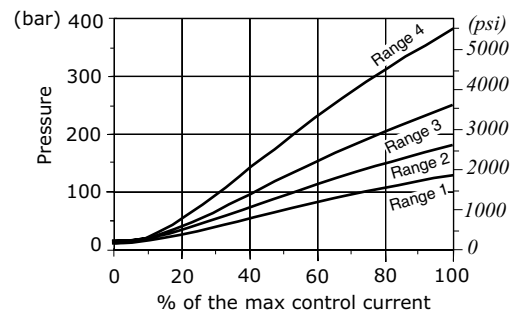

**MP12X pressure vs. flow 1->2**

for % of control current - Pressure range 1 -

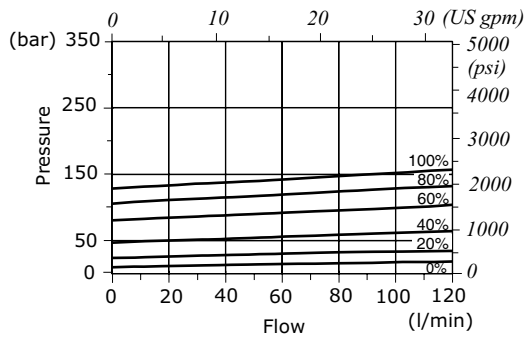

**MP12X pressure vs. flow 1->2**

for % of control current - Pressure range 2 -

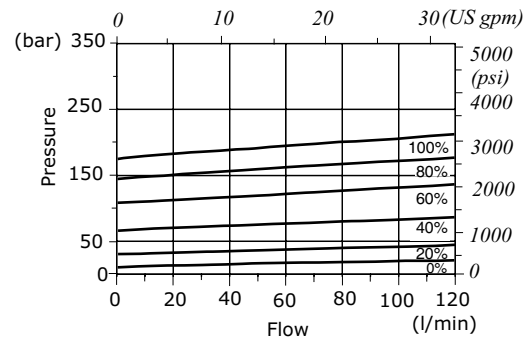

**MP12X pressure vs. flow 1->2**

for % of control current - Pressure range 3 -

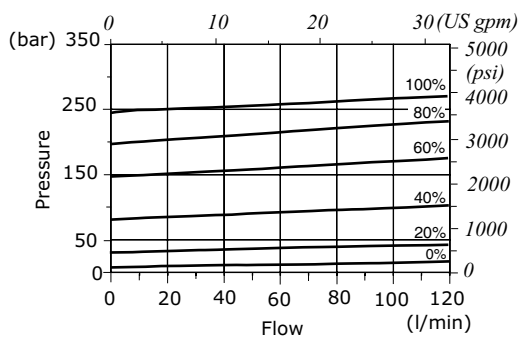

**MP12X pressure vs. flow 1->2**

for % of control current - Pressure range 4 -

